

Parts Identification Guide
PIB012/0406

TrueBlend™

Model TB900

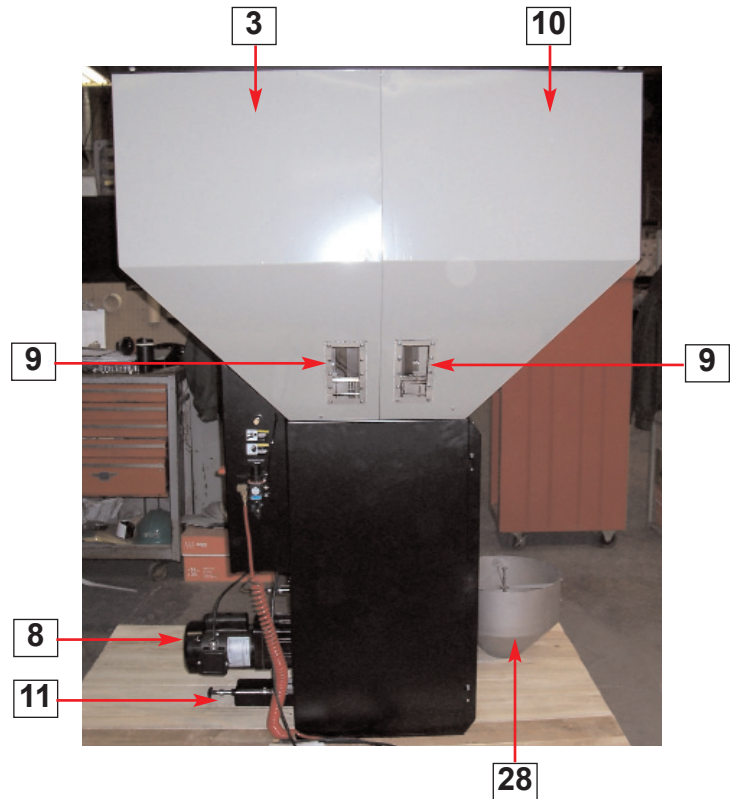

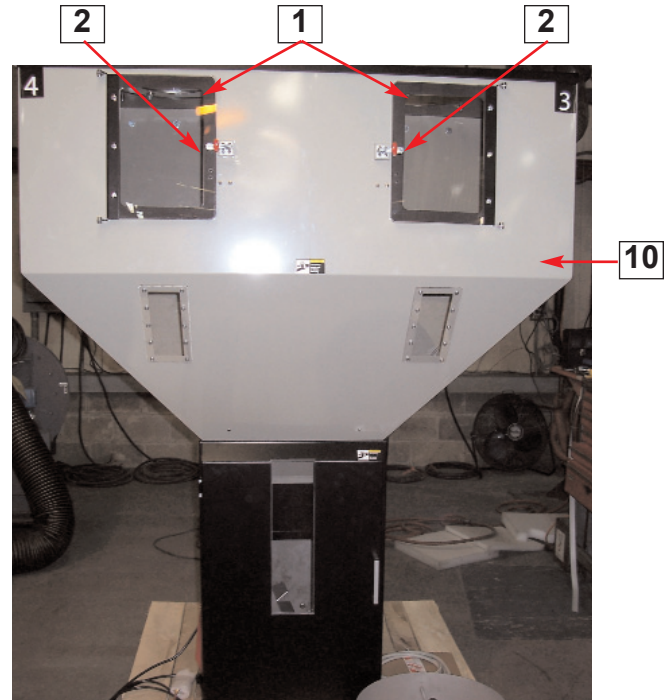
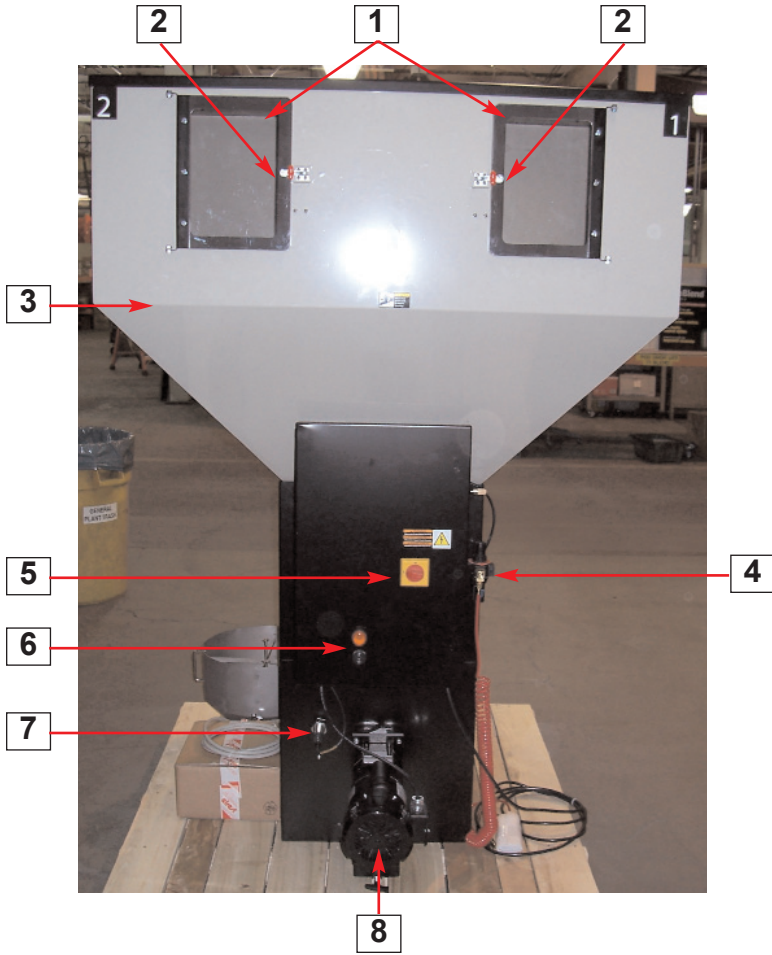

**TrueBlend
Model TB900**

- 1. Door Assembly
- 2. Toggle Clamps
- 3. Main Bin
- 4. Air Filter / Regulator / Hose
- 5. Disconnect Switch
- 6. Alarm Light and Horn
- 7. Mixing Sensor
- 8. Mix Motor
- 9. Sight Glasses
- 10. Color and Additive Bin
- 11. Air-Operated Slide Gate Assembly
- 28. Weigh Bin

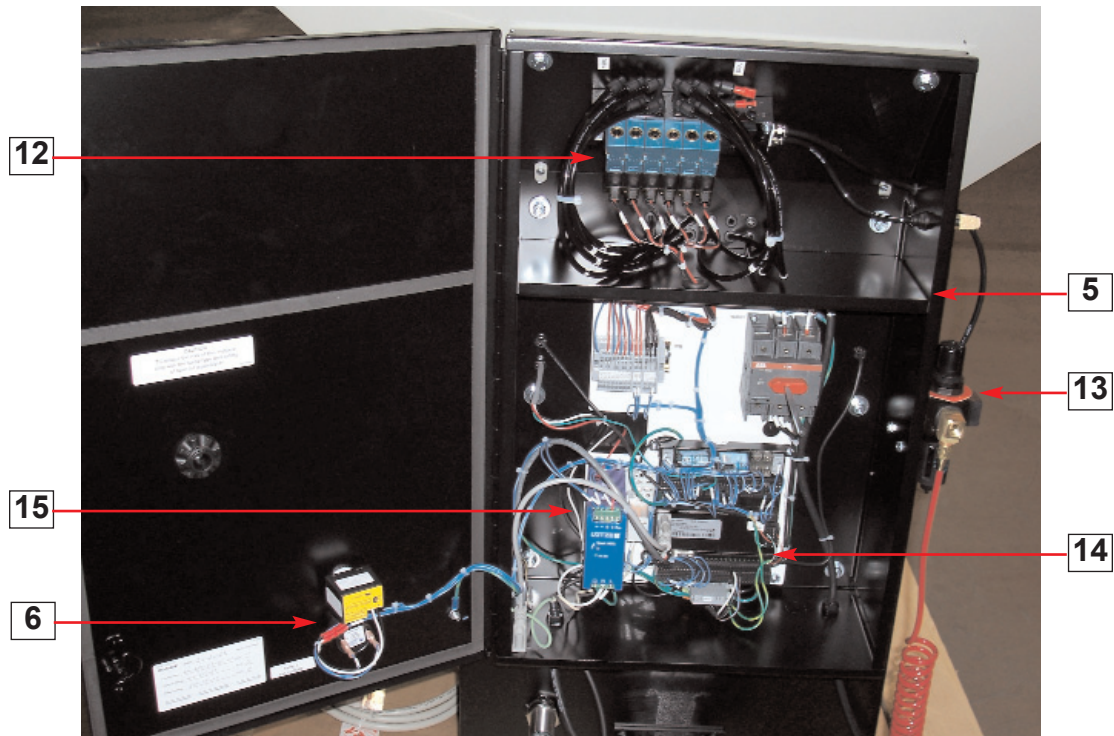

**TrueBlend
Model TB900**

- 5. Disconnect Switch
- 6. Alarm Light and Horn
- 12. Solenoid Valve
- 13. Air Filter Regulator
- 14. PLC
- 15. Power Supply

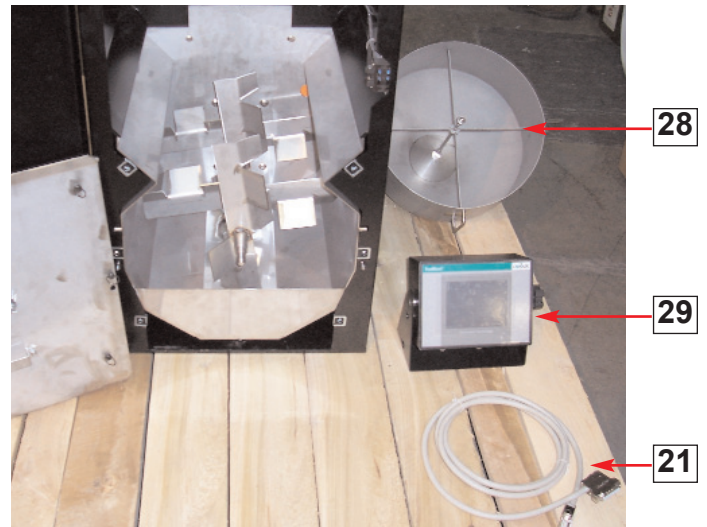
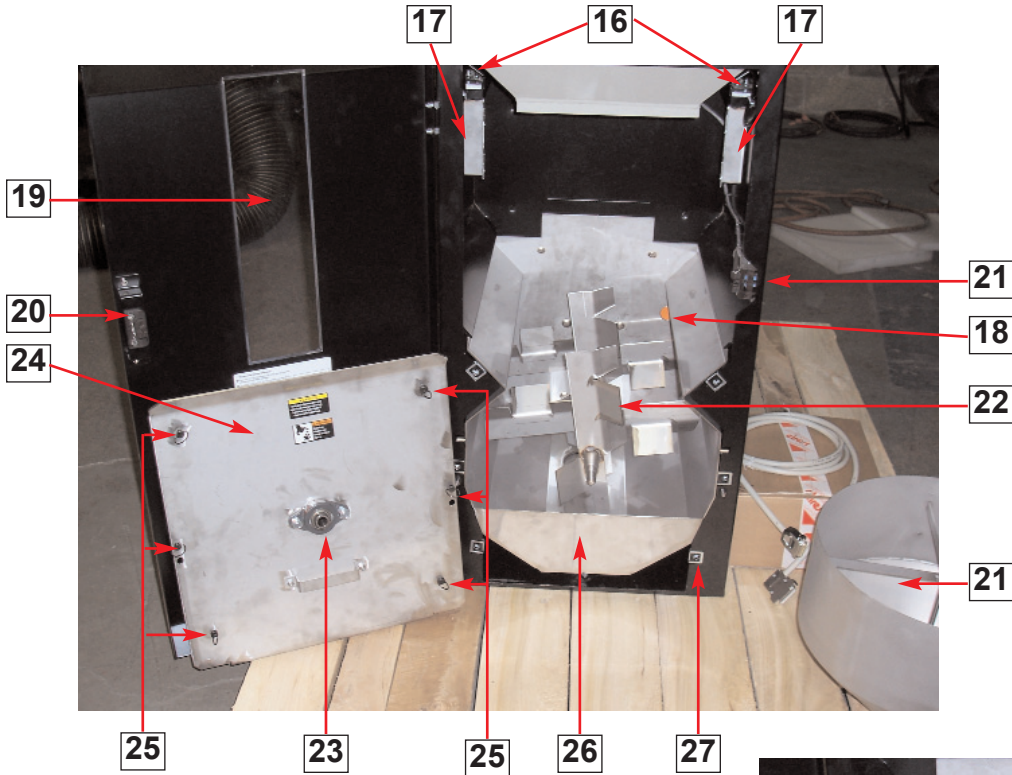

**TrueBlend
Model TB900**

- 16. Load Cell
- 17. Weigh Bin Bracket
- 18. Mix Sensor
- 19. Mix Chamber Sight Glass
- 20. Part of Security Latch Kit
- 21. Security Latch Kit
- 22. Agitator
- 23. Agitator Bearing
- 24. Front Cover
- 25. Turn Fasteners (6)
- 26. Mix Chamber Insert
- 27. Clip-on Retainer (6)
- 28. Weigh Bin
- 29. Touch Screen Operator Control
- 30. Control Cable

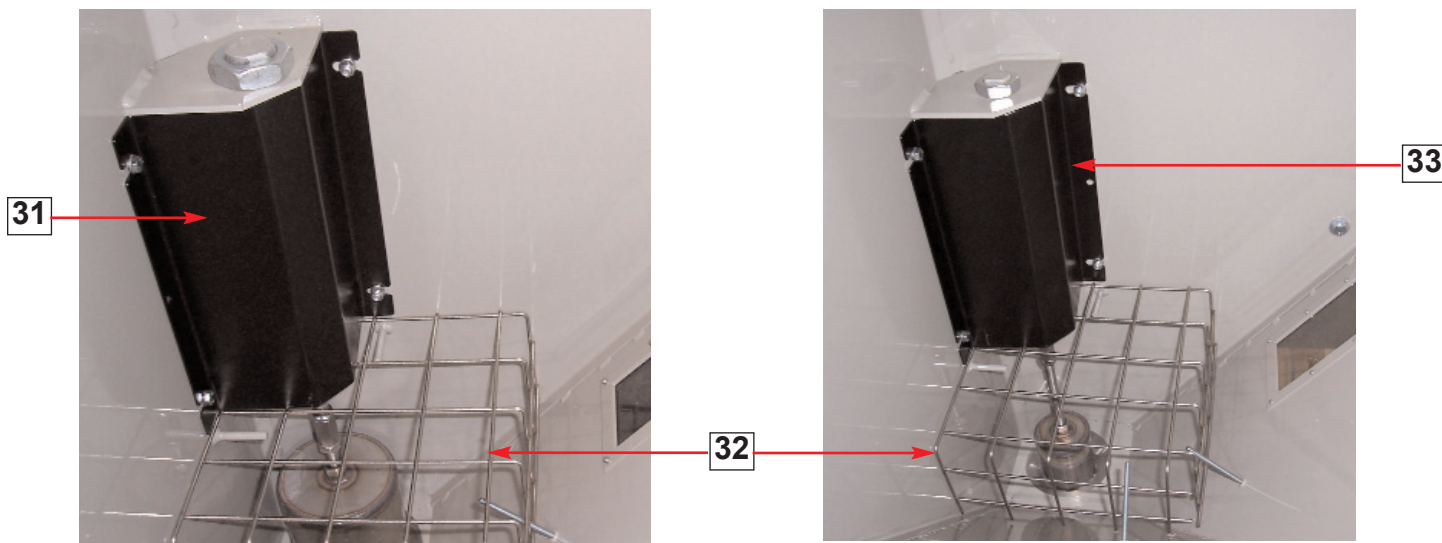

**TrueBlend
Model TB900**

- 31. Large Dosing Assembly for Main Bin
- 32. Finger Guard
- 33. Small Dosing Assembly for Color and Additive Bin